

Leben im Bad
Living bathrooms

 DURAVIT

Starck 3



Philippe Starck takes us into a world where the superfluous becomes superfluous. Into a bathroom that makes do without pomp and circumstance. With his acute sense for essentials, the designer unmasks decorations and ornaments for what they are: Kitsch. He proves this point with his bathroom ranges Starck 1 and Starck 2 – a designer's symposium on minimalism, made by Duravit. And now we are taking it one step further. More sizes at minimised prices. For design novices as well as for the advanced. Outstanding and unmistakable. Complete and ideal for large and small projects: offices, schools, hotels, airports and industry. Or for your home. Starck 3 offers suitable solutions for every space, meeting all national and international standards. Starck 3. Making a splash.



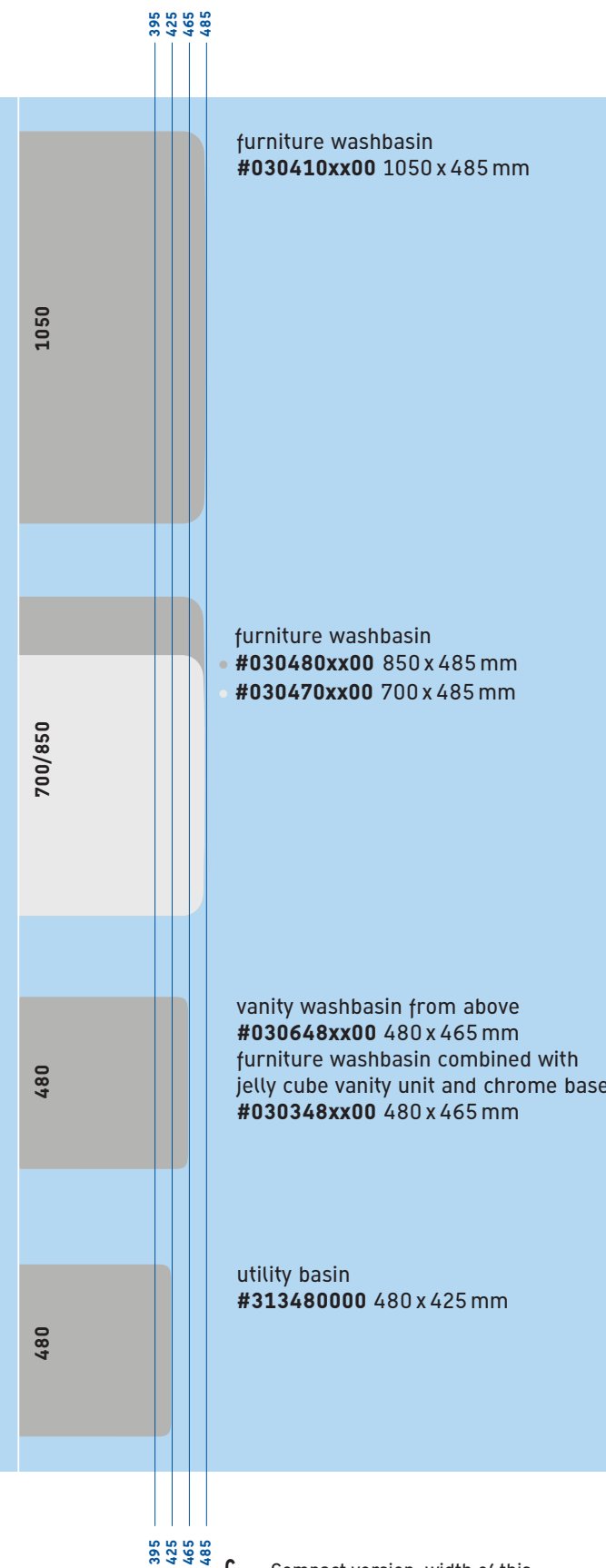
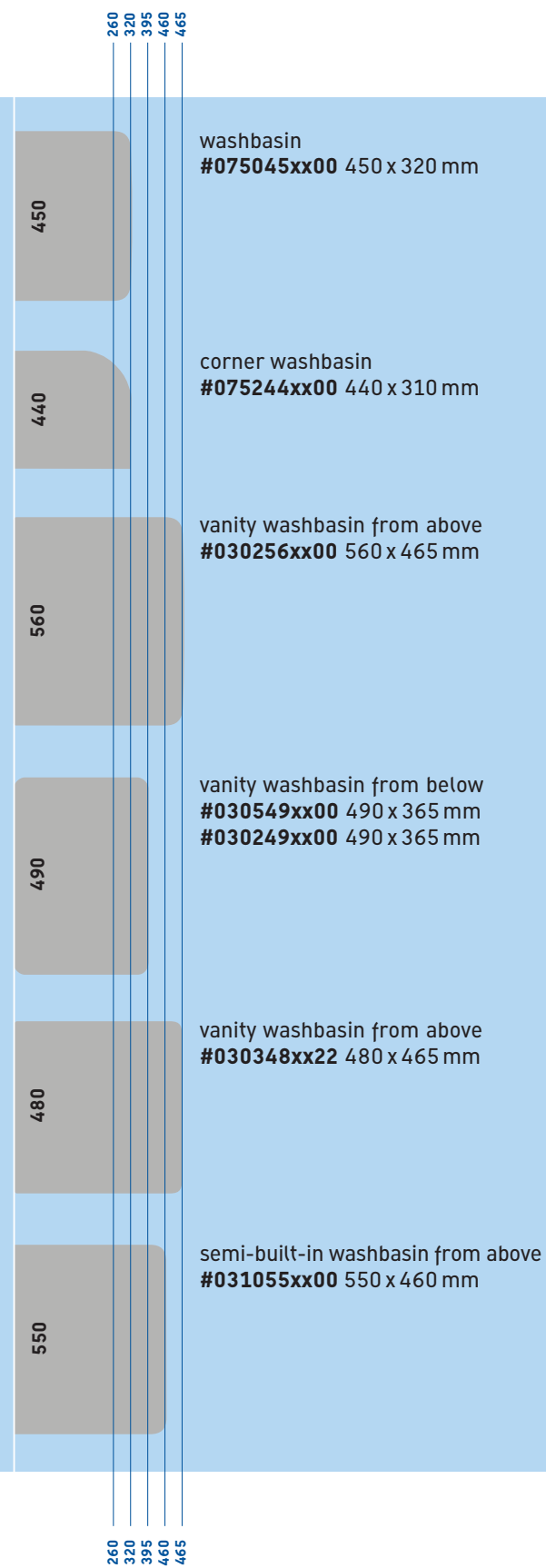
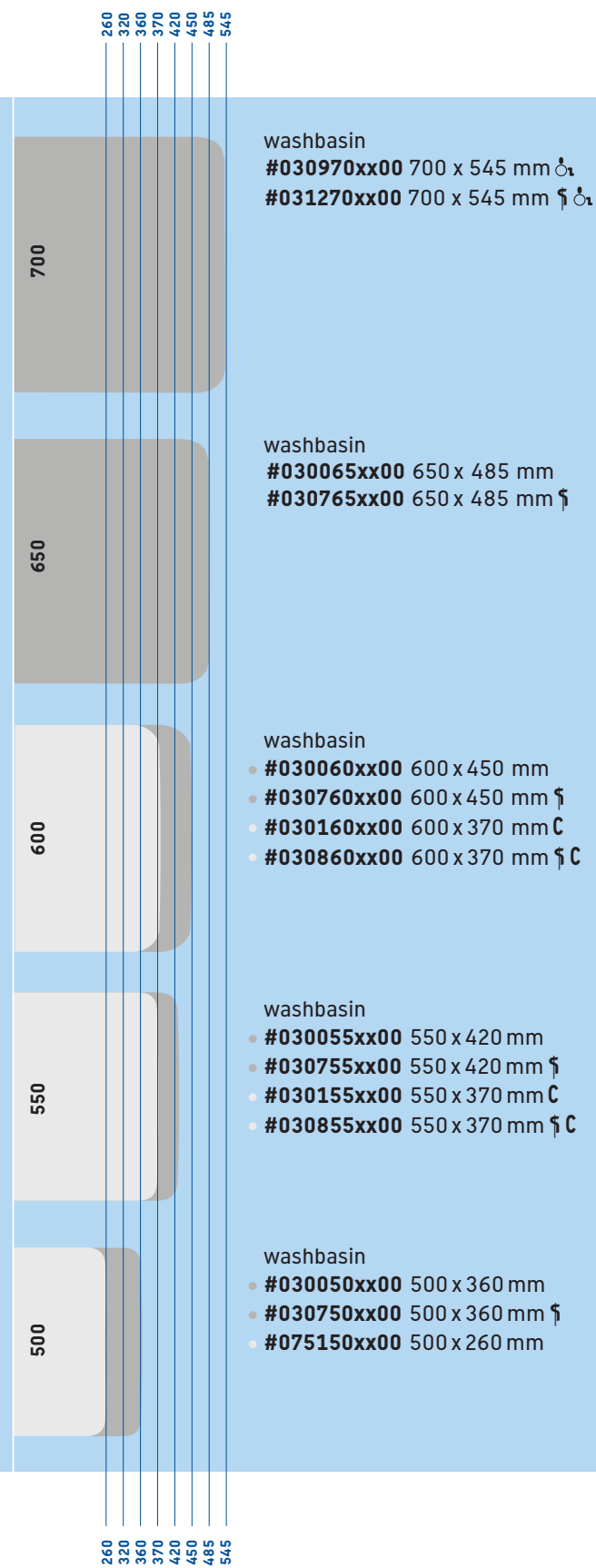

C = Compact version, width of this version identical, reduced depth.
 ♀ = Med version, without overflow, optional with tap hole.
 ♂ = suitable for wheelchair users, barrier-free
 xx = 00 White (Alpin), 47 Pergamon
 ♂ vertical outlet ⇨ horizontal outlet





Beautifully simple: the rectangle as a space-saving basic shape for washbasins with low back panel.

Compact sizes: smart solutions for washbasins of different depths and a width of 600 mm and 550 mm.

Complete bathroom: all-purpose, all sizes. From corner handrinse basins to furniture washbasins.

Practical: Starck 3 Med, without overflow, ideal for surgeries and hospitals. Also as Compact version.

Brilliant combinations: Washbasin with the new jelly cube vanity unit, furniture washbasin, with either pedestal or siphon cover, to go with Duravit furniture ranges like in the mood, X-Large and Starck 1.2.3.



Same width, different projection: on left, the 600 mm wide Starck 3 washbasin and on right the compact version.



How many elements does a designer really need? Line, circle and square are the basics of every object designed to last longer than just one season. Philippe Starck knows this – in his new bathroom range he is doing away with the unnecessary. The Starck 3 washbasin derives its distinctive character from its basic rectangular shape, an all-round rim and a low back panel. In contrast to semicircular washbasins of comparable size, the rectangular shape offers a wider variety of space-saving sizes. So smart, so brilliant, so very Starck.



Clever material mix: The Starck 3 furniture washbasin with ceramic rear panel finds a very supportive partner in the translucent plastic jelly cube vanity unit, which is available in snow white and ice-blue.

The Starck 3 furniture washbasin, 850 mm wide, with base unit from the x-large furniture range in Helsinki Birch (Décor) and 700 mm wide with x-large in dark Wengé (Décor).





030410xx00
1050 x 485 mm



075244xx00
440 x 380 mm



030256xx00
560 x 460 mm



030480xx00
850 x 485 mm



030410xx00
1050 x 485 mm



030648xx00
480 x 465 mm



030160xx00
600 x 370 mm



030410xx00
1050 x 485 mm



075150xx00
500 x 260 mm



030348xx00
480 x 465 mm



030348xx00
480 x 465 mm



030648xx00
480 x 465 mm



030549xx00
490 x 360 mm



030249xx00
490 x 360 mm



031055xx00
550 x 460 mm



030970xx00
700 x 545 mm



075045xx00
450 x 320 mm



030470xx00
700 x 485 mm





The new Starck 1.2.3 bathroom furniture complements the range beautifully without abandoning the "less is more" philosophy. Vanity unit, container on casters, medicine and mirror cabinet.



Starck 3. Making a splash.



030970xx00 
031270xx00  

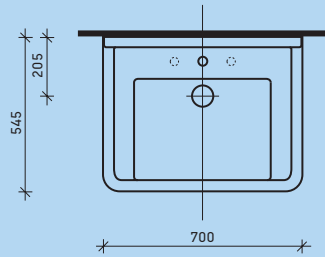

030065xx00
030765xx00 

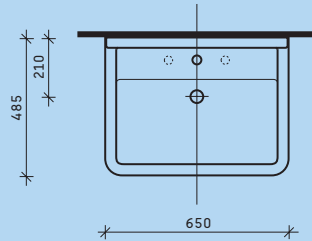

030060xx00
030760xx00 

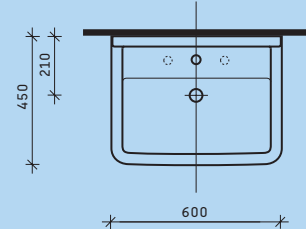

030160xx00 C
030860xx00  C

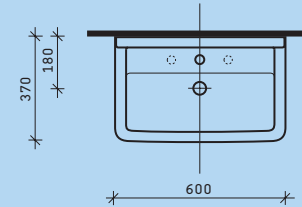

030055xx00
030755xx00 

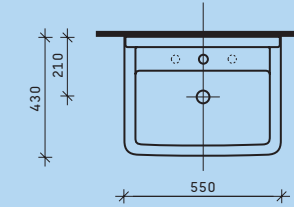

030155xx00 C
030855xx00  C

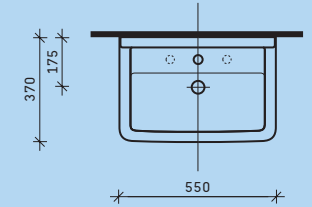

030050xx00
030750xx00 

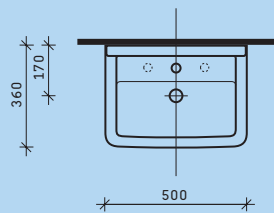

075045xx00

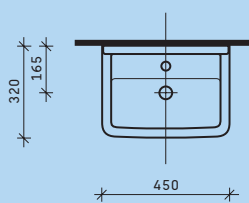

075150xx00

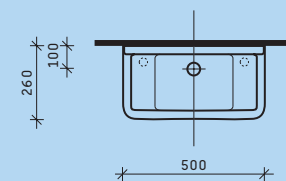

075244xx00

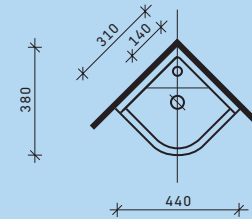

030256xx00 

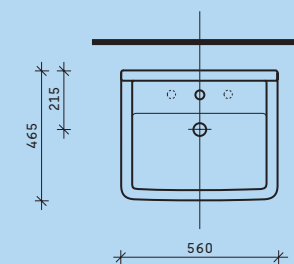

030249xx00 

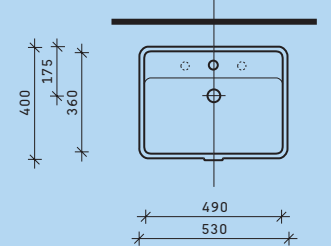

030549xx00 

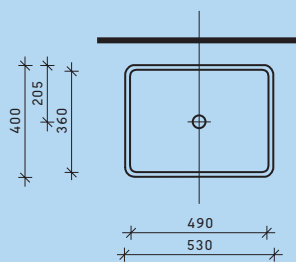

030155xx00

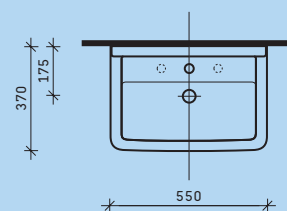

030648xx00 # 030348xx22 

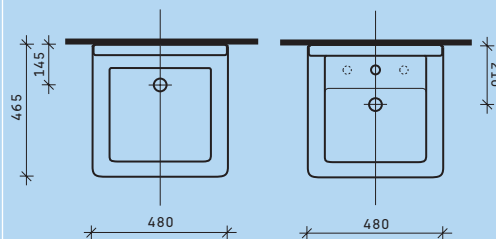

0313480000

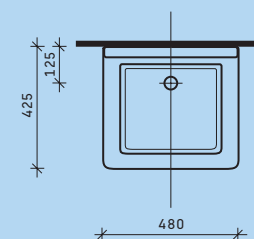



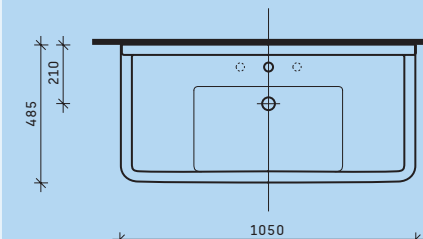

030410xx00

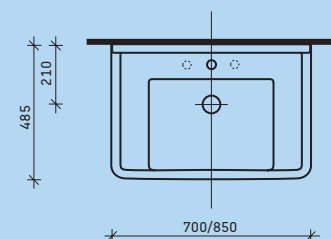

030470xx00
030480xx00



- C** = Compact version, width of this version identical, reduced depth.
-  = Med version, without overflow, optional with tap hole.
-  = suitable for wheelchair users, barrier-free
- xx = 00** White (Alpin), **47** Pergamon
-  = installation from below
-  = installation from above

The toilet: a fundamental part of every bathroom and yet often neglected by most designers. Not so by Philippe Starck for Duravit. Treated with the same care as everything else, the Starck 3 toilet with concealed trap becomes the unmistakable highlight of the range. Well-designed appearance shouldn't compromise on performance: all toilets are equipped with Dual-Flush and both toilet and bidet are available as a floorstanding and wallmounted version. A urinal with matching ceramic partition completes the wide range. In fact, Starck 3 suits all requirements. Not only for public areas, but also for your home.



Well equipped: ceramic cisterns with Dual-Flush for 3- or 6-litre flushing action. Just press the smaller button to further reduce the volume of flushing water.

Perfect unity: same design, different functions. Both toilet and bidet are available as a floor-standing or wall-mounted version.

New: the matching bidet Compact combined with the wall-mounted toilet Compact.

Bathroom-aesthetics: the close-fitting toilet seat with overlapping cover underlines the clear character of the range. Understatement simplified.

High standard: a cleaner bathroom due to an 80 mm ground-clearance on wall-mounted toilets and bidets. One of the many floor-standing variations provides a 100 mm raised seat level. More convenience and quality of life.

Public Relations: urinals for public and semi-public areas. With water inlet from above or from the rear, with target fly upon request.

Unmistakable highlight: the Starck 3 toilet with concealed trap.



Numerous sizes available: e.g. the standard wall-mounted WC and bidet (left) and in the compact version, all with 80 mm floor clearance.



Aesthetics cum functionality, clockwise: wall-mounted toilet and bidet, wall-mounted toilet and bidet Compact, floor-mounted toilet and bidet with cistern and the "back-to-wall" floor-mounted toilet with matching bidet. On the left: the Starck 3 floor-mounted toilet.



Ideal for the public sector, clockwise: the Starck 3 urinal, optional with water inlet from above or from the rear and concealed water supply, the ceramic partition, the floor-mounted toilet with the seat height raised by 100 mm and the and the standard-height version.



A meaningful addition: the new barrier-free toilet with a 700 mm projection. With all-round water-rim and 3- and 6-litre flushing action, it is ideally suited for use in the public and semi-public sectors. The new toilet seat features a one-piece stainless steel hinge - and also fits all other Starck 3 toilets.



Two made of each other. Starck 3 wall-mounted toilet with 700 mm projection and the Starck 3 barrier-free washbasin. Both from the design studio of Philippe Starck.

220009xx00

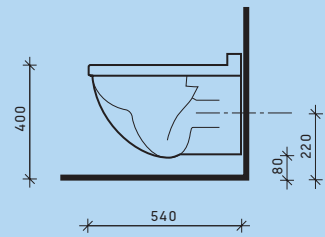

220109xx00

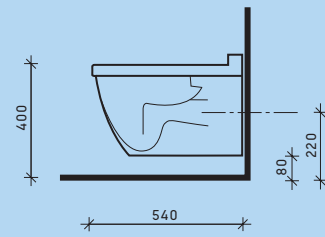

223015xx00

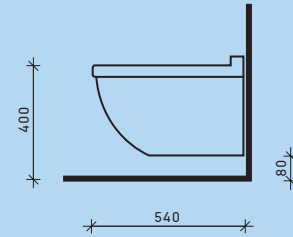

220209xx00 C

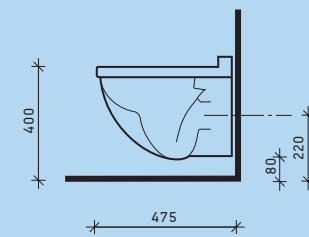

223115xx00 C

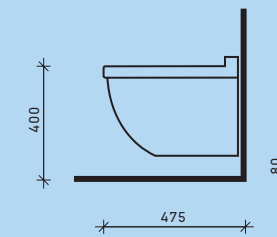

012601xx00

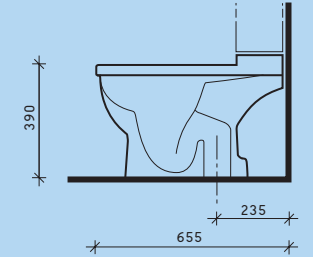

012609xx00

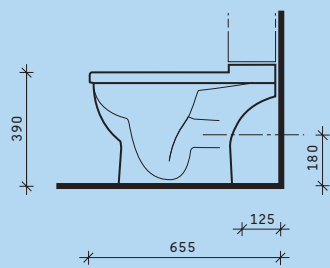

012809xx00

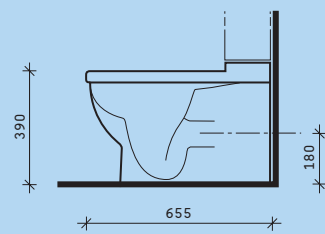

variants of Vario toilet

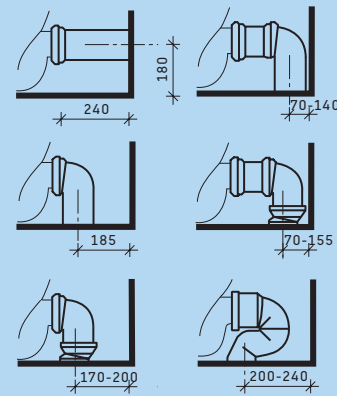

223410xx00

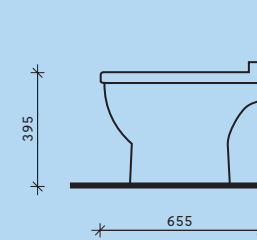

012409xx00

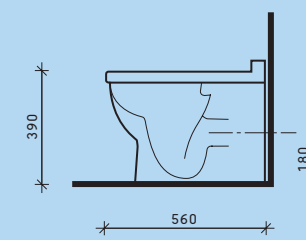

223010xx00

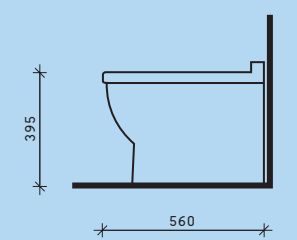

012709xx00 ♿

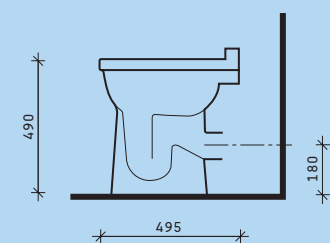

012909xx00 ♿

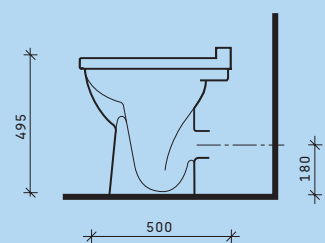

220309xx00 ♿

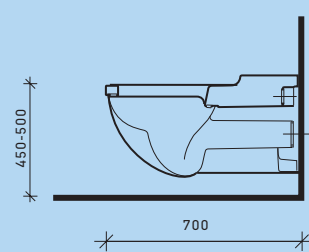

012509xx00

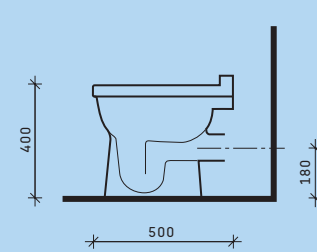

082135xx00

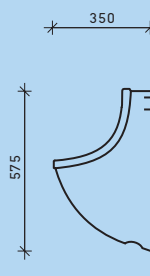

082235xx00

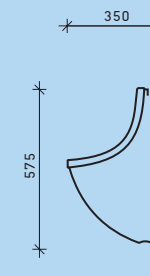

850000xx00

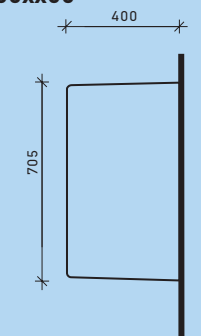

C = Compact version
 xx = 00 White (Alpin), 47 Pergamon
 ♿ = barrier-free

“Why do small people enjoy taking a bath a lot more than tall ones?” asked Philippe Starck and developed a tub which offers more design as well as more space and convenience. Thanks to optimal space solutions and an improved backrest, tall people can finally enjoy a full-body bath without being left high and dry, all in a tub that complies with standard exterior measurements. Either as it is or equipped with one of three whirlpool systems, the Starck 3 bathtubs will make you feel like a new person with every bath you take, regardless of your size. Don't forget the shower trays which are available as square, rectangle, pentagon or quarter circle. Among the wide variety of products, Philippe Starck's vision always remains visible: the creation of a bathroom range which is one of its kind. Immaculate. And uniquely comfortable.

Sparkling relaxation: whirlpool with Air-System, Jet System or the combined Air-Jet-Systems, Combi-System P and Combi-System E.

Additional comfort features upon request: foot- and back-massage, each with adjustable rotating jets. Water temperature is controlled by an inline heater. A halogen lighting element creates a relaxing atmosphere.

Archetypical yet generous: the bathtub with minimal exterior measurements offers maximum space and convenience. Also for two people.

Variety of shapes: four tubs, one design. Sizes from 1600 mm to 2000 mm.

Spotlessly clean: the standard equipment provides for full-system drainage. Upon request, all systems can be equipped with hygiene management system providing maximum peace of mind.

Convenient: extra-long backrest with integrated headrest. Additional convenience: Soft-Headrest – made from a hygienic, easy-to-clean synthetic material.

Corresponding shapes: Starck 3 shower trays, in either a square, rectangular, pentagon or quarter circle shape. Built-in or with integrated panel.



Variety of shapes, clockwise: the basic shapes of the Starck 3 shower trays, quarter circle, pentagon, square, rectangle. Shower trays are made of sanitary acrylic and are available as built-in version. The quarter circle and pentagonal trays are also available with integrated panel.

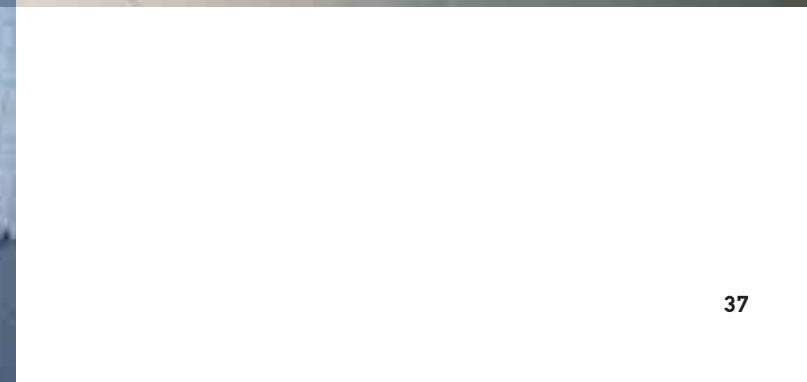

Bathtime enjoyment – alone or à deux: on the left the two-seater Starck 3 whirltub 1800 x 800 mm, with Combi-System E, hygiene management and two headrests. Wellness at the touch of a button: via the control panel (small picture, lower left-hand corner), you can regulate the Air- and Jet-System and the rotating jets for the respective whirlpool function – as well as the mood-creating underwater lighting (from upper left to lower right).



Mood change: when touched, the unobtrusive operating unit of the Combi-System L lights up in blue (small picture centre and right).

700001xx 1600 x 700 mm

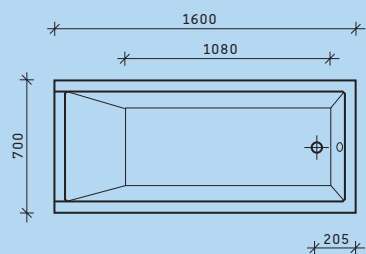

700002xx 1700 x 700 mm
700003xx 1700 x 750 mm*

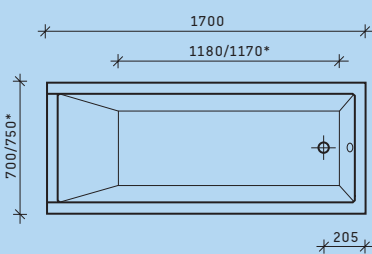

700004xx 1800 x 800 mm
700031xx 1900 x 900 mm
700032xx 2000 x 1000 mm

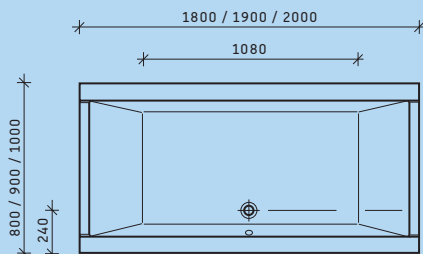

720001xx 900 x 900 mm
720002xx 900 x 900 mm*

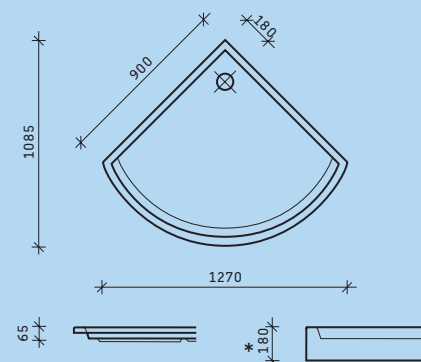

720003xx 1000 x 1000 mm
720004xx 1000 x 1000 mm*

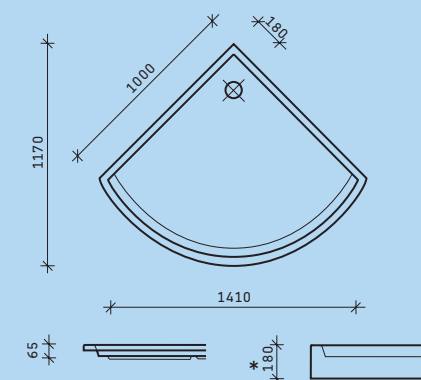

720030xx 900 x 900 mm
720032xx 1000 x 1000 mm

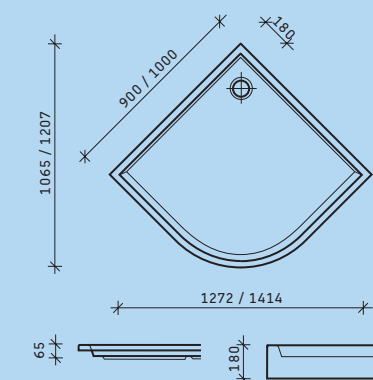

720007xx 1000 x 1000 mm
720008xx 1000 x 1000 mm*

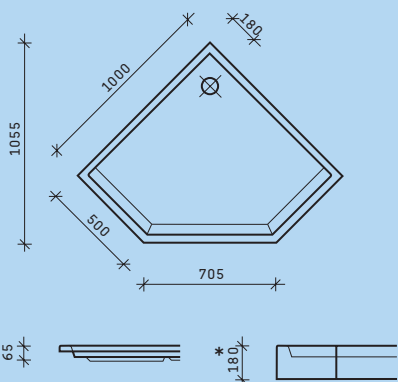

720005xx 900 x 900 mm
720006xx 900 x 900 mm*

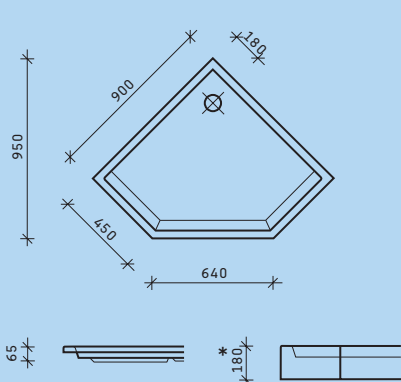

720009xx 800 x 800 mm
720010xx 900 x 900 mm

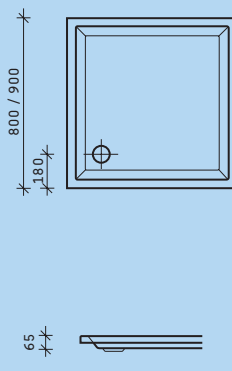

720011xx 1000 x 1000 mm

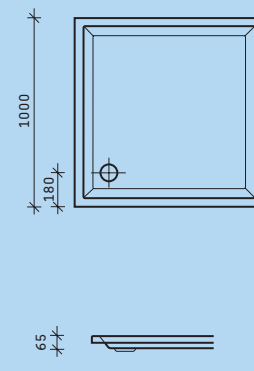

720012xx 900 x 750 mm
720013xx 900 x 800 mm

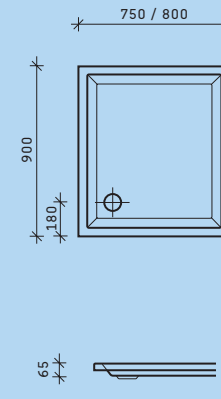

720036xx 700 x 1500 mm
720037xx 750 x 1500 mm

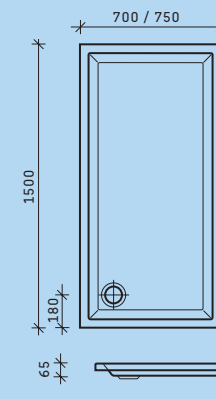

720014xx 800 x 1000 mm

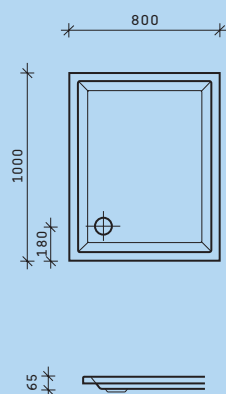

720015xx 900 x 1000 mm
720017xx 900 x 1200 mm

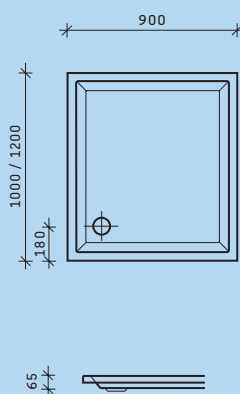

720016xx 800 x 1200 mm
720018xx 1000 x 1200 mm

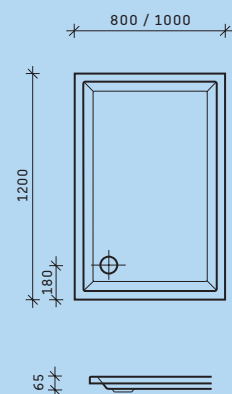

720041xx 900 x 1700 mm
720042xx 900 x 1800 mm

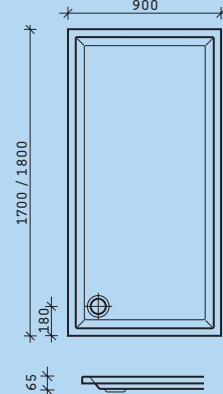

720038xx 700 x 1600 mm
720039xx 750 x 1600 mm
720040xx 900 x 1600 mm

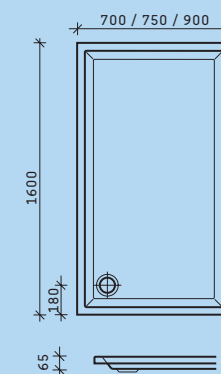

720034xx 700 x 1400 mm
720019xx 750 x 1400 mm
720035xx 900 x 1400 mm

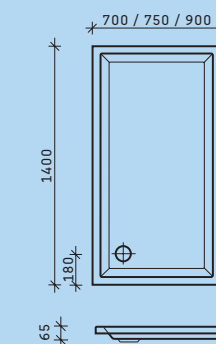

xx = 00 White (Alpin), 47 Pergamon

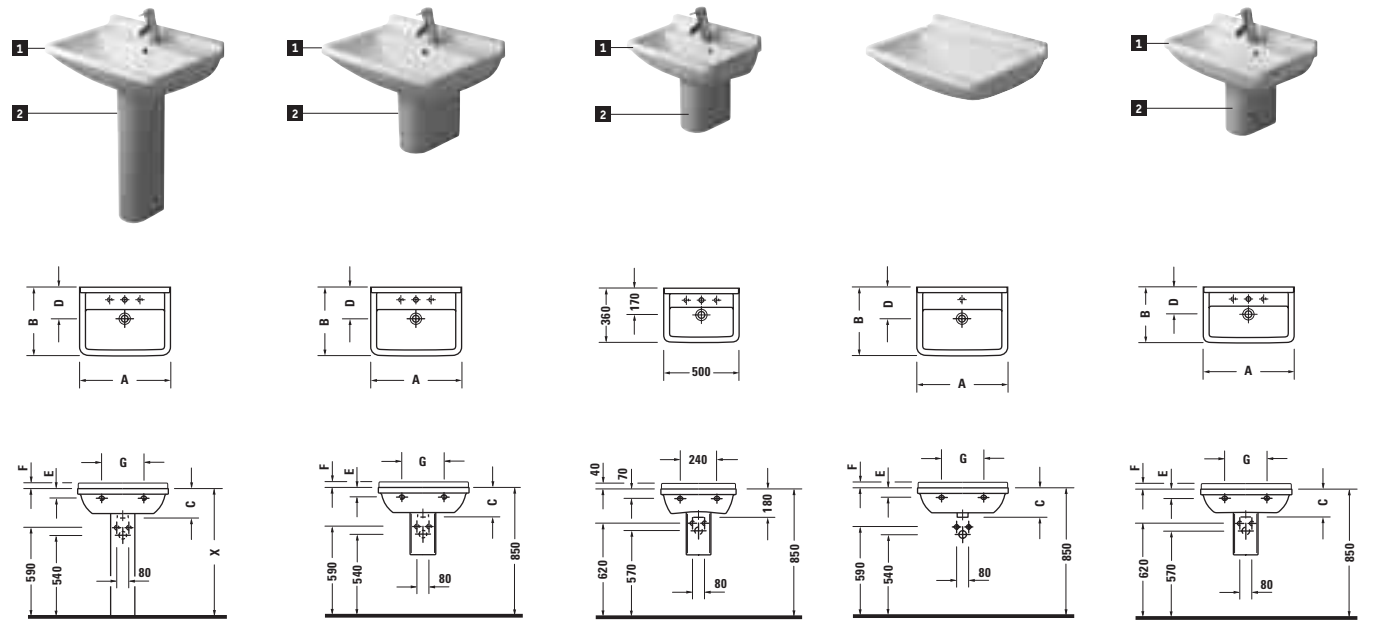

A	B	C	D	E	F	G	
650 mm	650	485	200	210	65	35	280
600 mm	600	450	190	210	65	35	280
550 mm	550	430	190	210	70	35	280

- 1 # 030065.00 ○ ● ○
- 2 # 030060.00 ○ ● ○
- 3 # 030055.00 ○ ● ○
- 4 # 086516.00

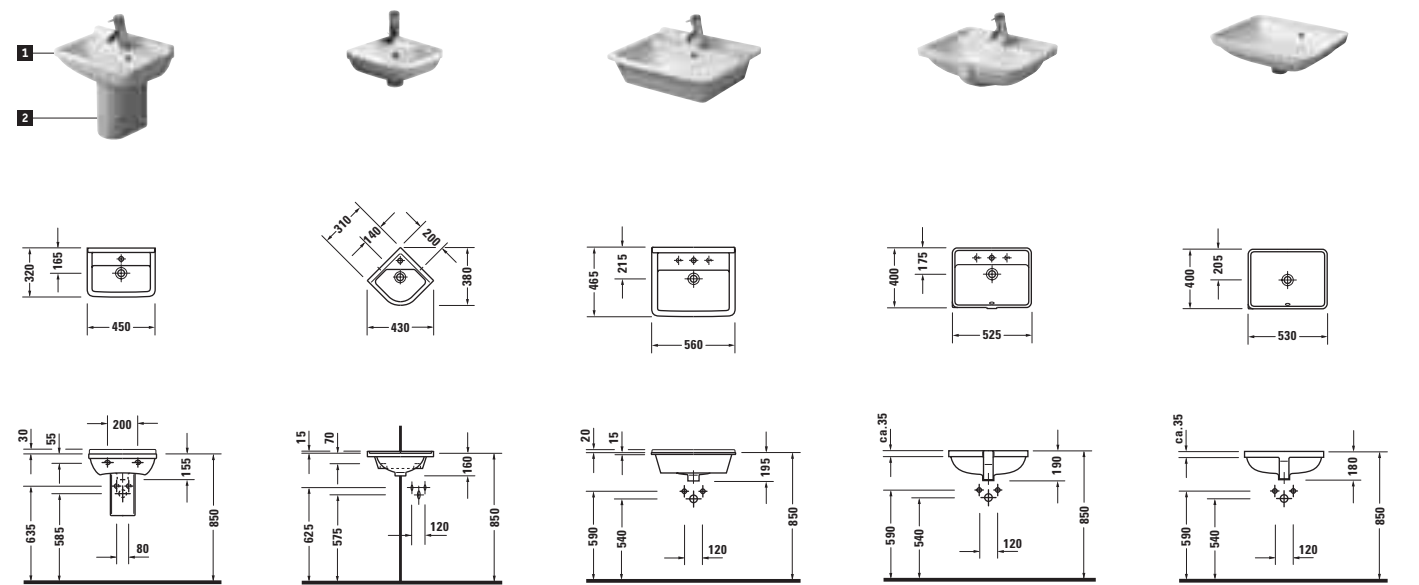

- 1 # 075045.00 ●
- 2 # 086517.00
- # 075244.00 ●
- # 030256.00 ○ ● ○
- # 030249.00 ○ ● ○
- # 030549.00 ○ ● ○

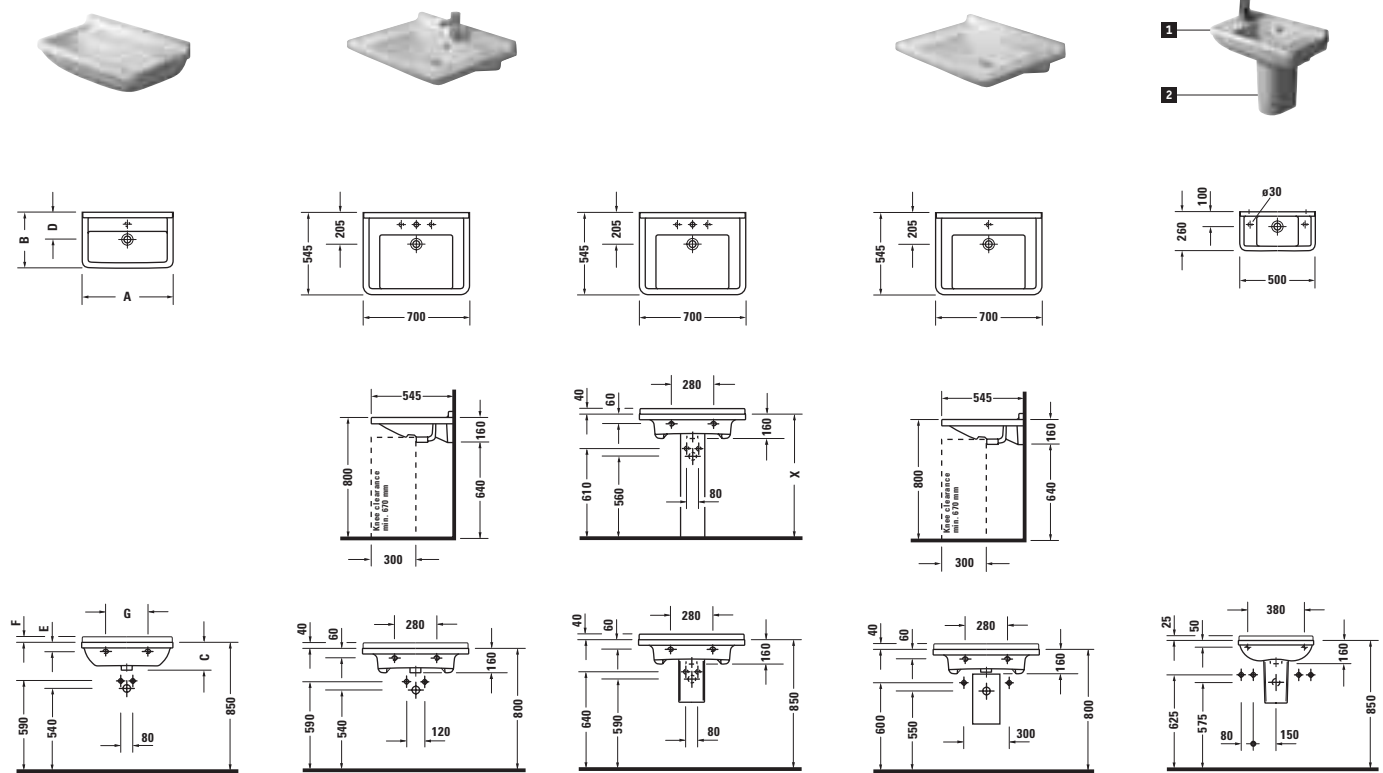

A	B	C	D	E	F	G	
600 mm	600	370	180	180	65	35	280
550 mm	550	370	180	175	65	35	280

- MedCompact
- # 0308600000 ●
- # 0308550000 ●
- Barrier-free washbasin
- # 030970.00 ○ ● ○
- # 086516.00
- # 086515.00
- Barrier-free washbasin
- # 031270.00 ●
- In-wall-siphon Geberit
- 151.110.11.1 with
- Duravit-Special slotted waste
- 0050381000
- 1 # 075150.00 ● ●
- 2 # 086518.00

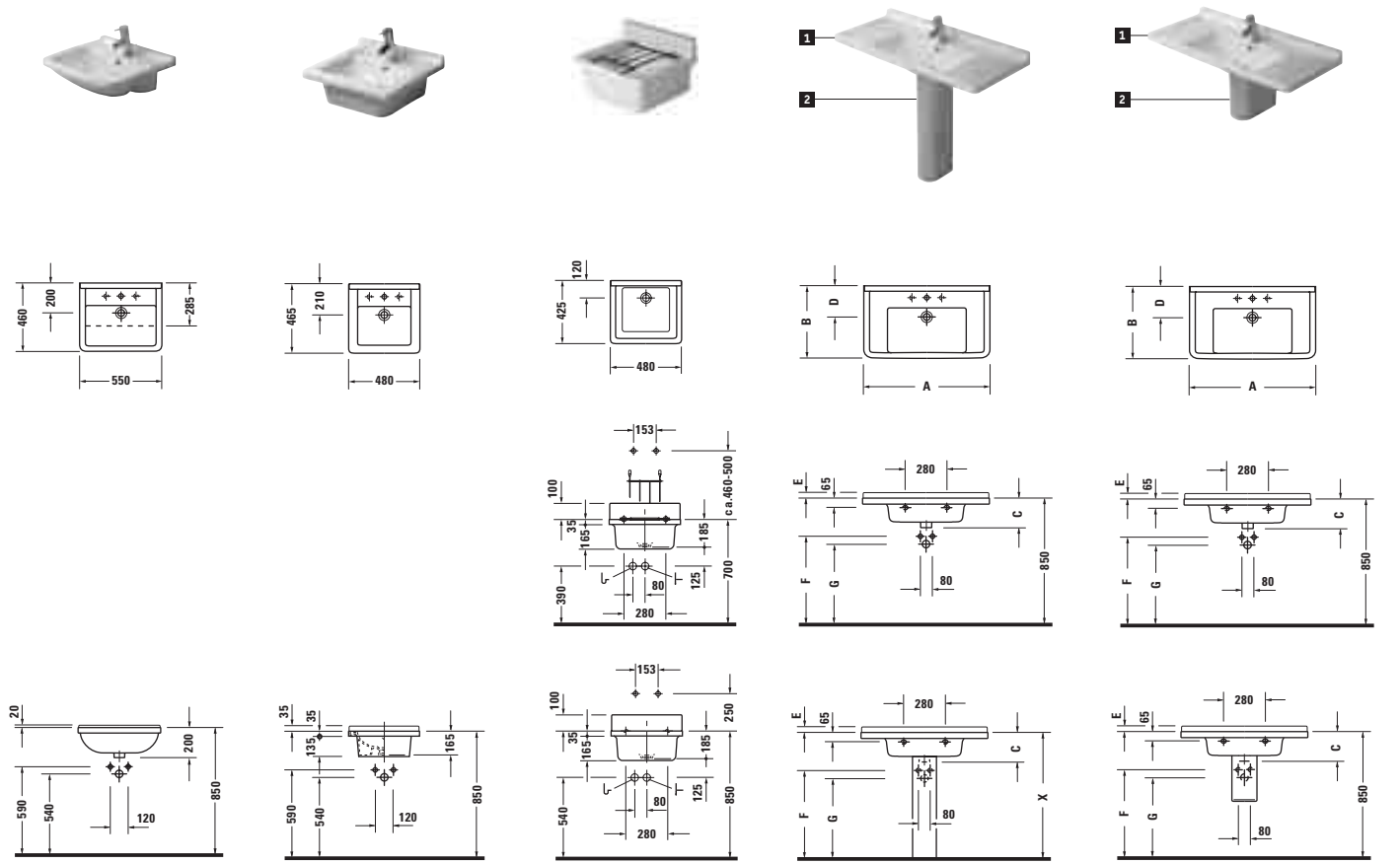

- # 031055.00 ○ ● ○
- # 030348.22 ○ ● ○
- # 0313480000 ☒
- 1 # 030410.00 ○ ● ○
- 2 # 030480.00 ○ ● ○
- 3 # 030470.00 ○ ● ○
- 4 # 086516.00
- 1 # 030410.00 ○ ● ○
- 2 # 030480.00 ○ ● ○
- 3 # 030470.00 ○ ● ○
- 4 # 086515.00

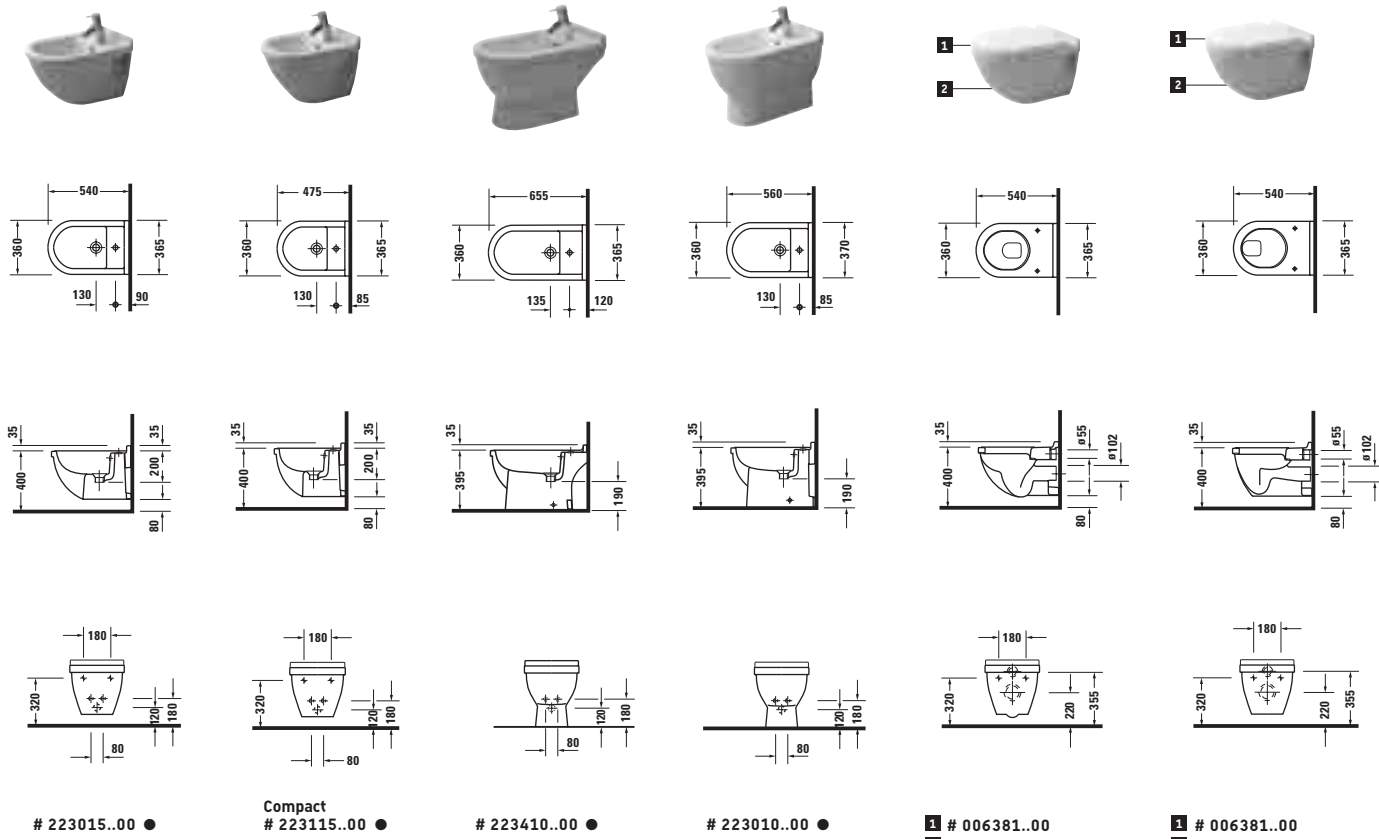

- # 223015..00 ●
- Compact # 223115..00 ●
- # 223410..00 ●
- # 223010..00 ●
- # 006381..00
220009..00 ♣
- # 006381..00
220109..00 ♣

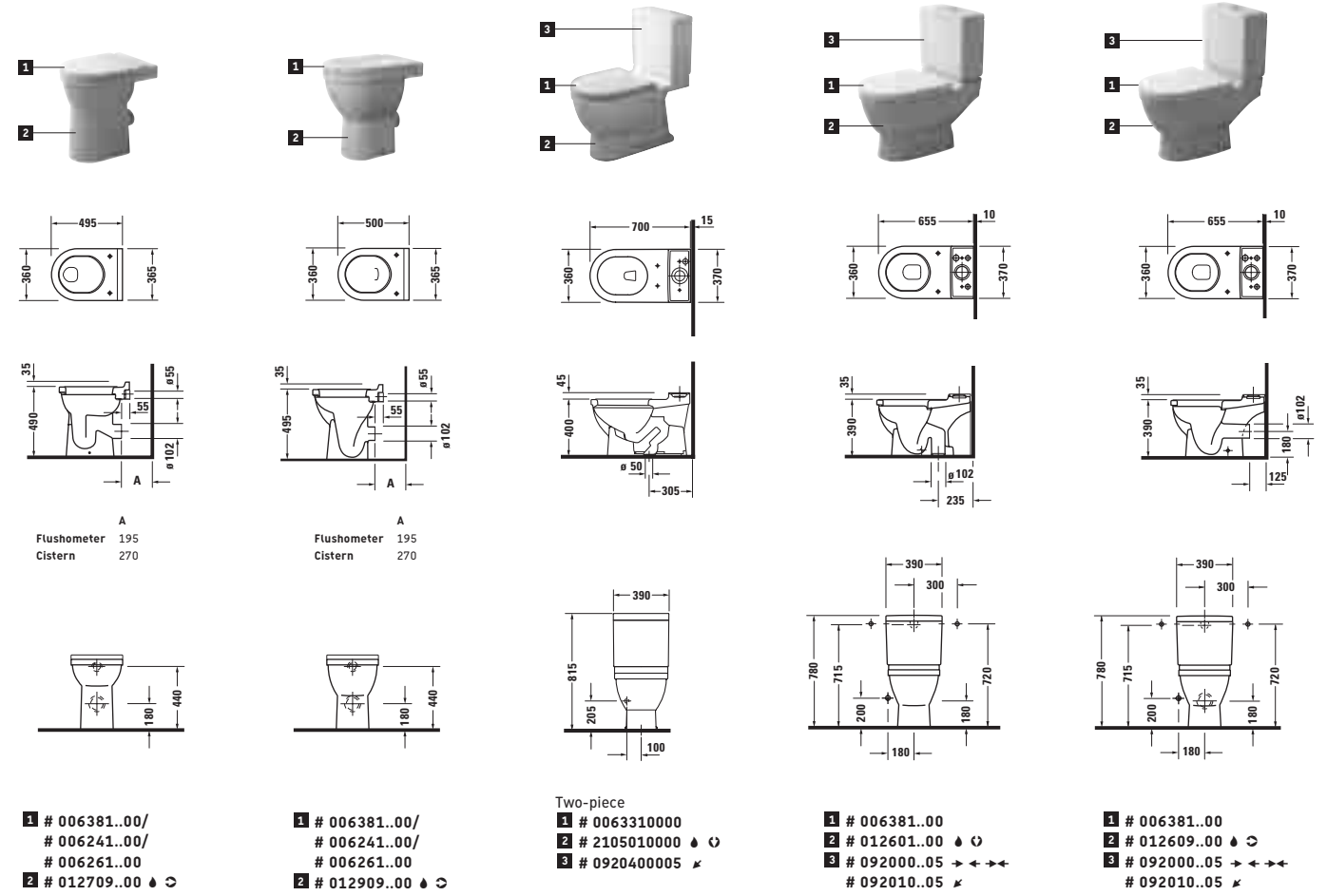

- # 006381..00
012601..00 ♣
092000..05 → ♣
- # 006381..00
012609..00 ♣
092000..05 → ♣
- # 006381..00
012609..00 ♣
092000..05 → ♣

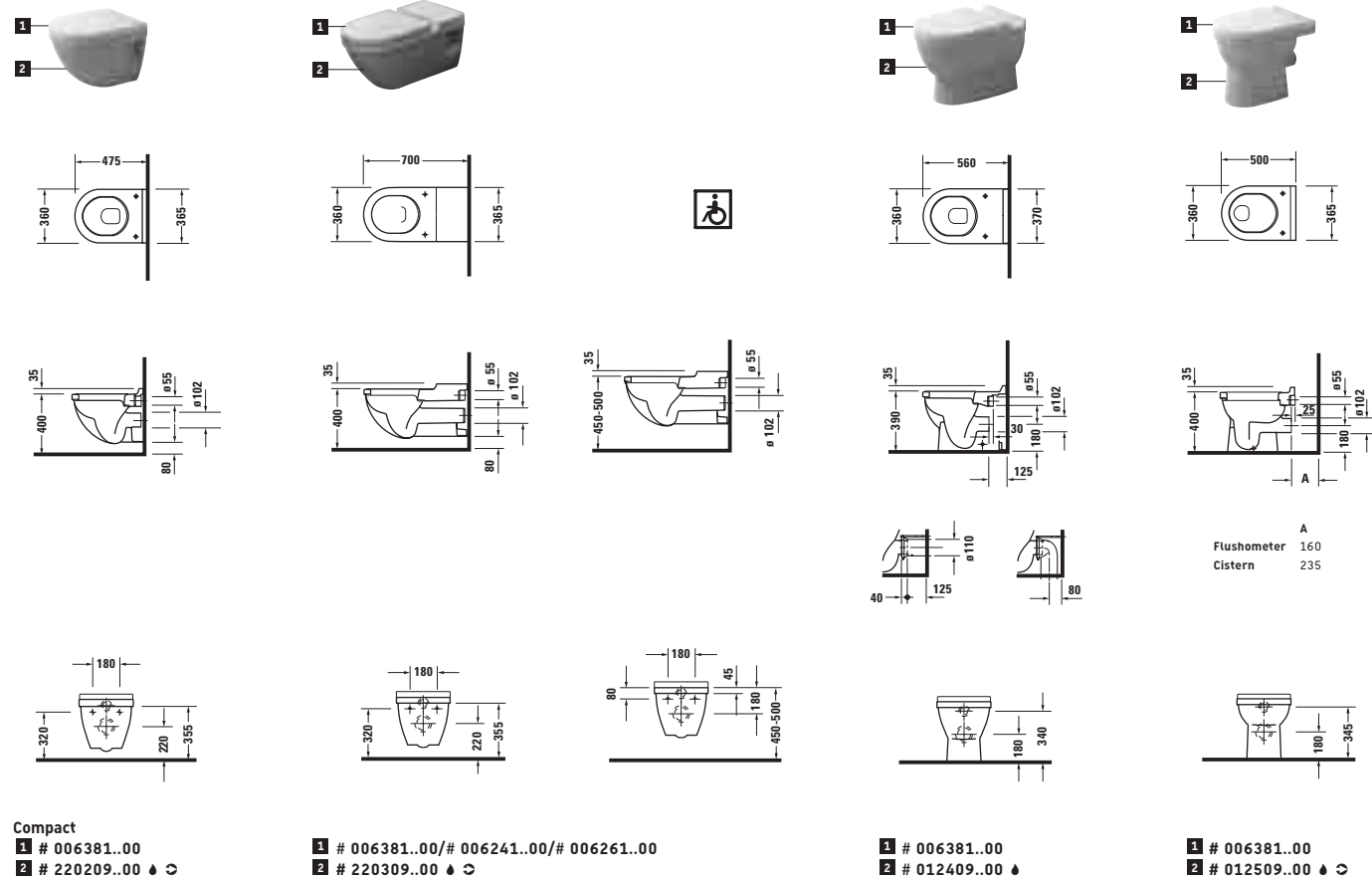

- Compact # 006381..00
220209..00 ♣
- # 006381..00/
006241..00/
006261..00
220309..00 ♣
- # 006381..00
012409..00 ♣
- # 006381..00
012509..00 ♣

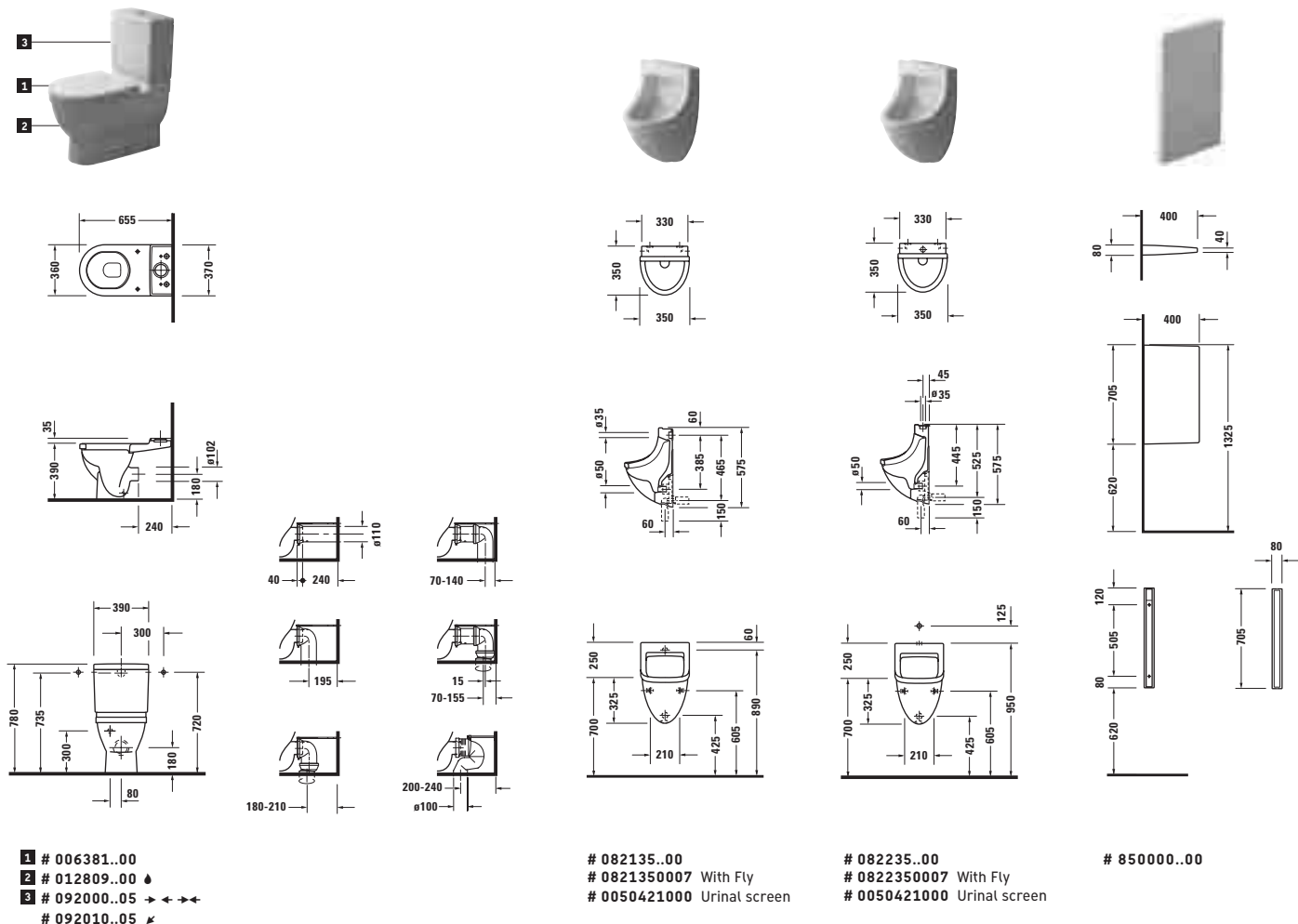

- # 082135..00
0821350007 With Fly
0050421000 Urinal screen
- # 082235..00
0822350007 With Fly
0050421000 Urinal screen
- # 850000..00



700001 .. 0 00 0000, 1600 x 700 mm
 # 700002 .. 0 00 0000, 1700 x 700 mm
 # 700003 .. 0 00 0000, 1700 x 750 mm

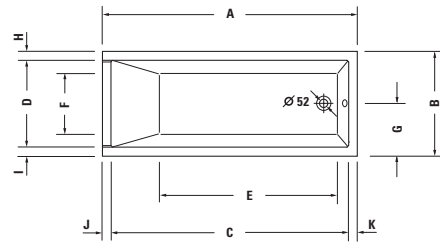

	A	B	C	D	E	F	G	H	I	J	K
#700001	1600	700	1470	570	1080	400	350	65	65	65	65
#700002	1700	700	1570	570	1180	400	350	65	65	65	65
#700003	1700	750	1555	590	1170	400	375	80	80	65	80

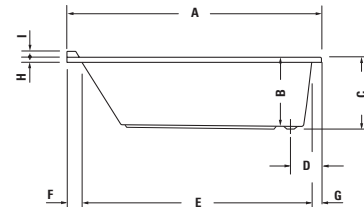

	A	B	C	D	E	F	G	H	I
#700001	1600	460	ca.485	205	1435	100	65	35	50
#700002	1700	460	ca.485	205	1535	100	65	35	50
#700003	1700	460	ca.485	230	1515	105	80	35	50



700004 .. 0 00 0000, 1800 x 800 mm
 # 700031 .. 0 00 0000, 1900 x 900 mm
 # 700032 .. 0 00 0000, 2000 x 1000 mm

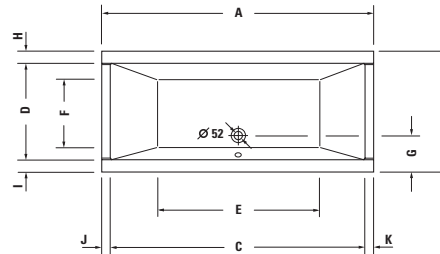

	A	B	C	D	E	F	G	H	I	J	K
#700004	1800	800	1670	640	1080	460	240	80	80	65	65
#700031	1900	900	1770	700	1175	560	250	100	100	65	65
#700032	2000	1000	1870	800	1275	660	250	100	100	65	65

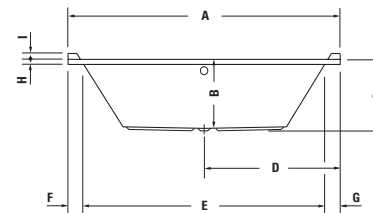

	A	B	C	D	E	F	G	H	I
#700004	1800	460	ca.485	900	1590	105	105	35	50
#700031	1900	460	ca.485	950	1690	105	105	35	50
#700032	2000	460	ca.485	1000	1790	105	105	35	50

Additional modules for Combi-System E

Back-Massage

3 adjustable rotating jets have a beneficial effect on the back.



Foot-Massage

2 adjustable rotating jets are stimulating the reflex zones of the foot.



Lighting

1 underwater light, 50 W halogene, creates a cosy atmosphere in the bathroom.



Inline Heater

Electronically controlled thermal system to compensate for loss of temperature during whirl action.



Hygiene Management

Electronically controlled cleaning system for the desinfection of the jets and pipes of the whirlsystem.



Additional modules for Combi-System L

Coloured Light

The tub is flooded with light that changes colour constantly. Five light elements integrated into the side wall allow the user to select a colour in accordance with the atmosphere. Halogene spot is going to be replaced.



Temperature L

Heating module with blue backlit LCD display and control. This system can be used to heat the whirlpool to the desired temperature.



UV Hygiene Management

Simple, environmentally-friendly hygiene by means of automatic UV disinfection.



The standard equipment of Duravit Whirlsystems provides full system drainage as well as pop-up waste and overflow fitting, chrome.



71.... 1 .. 10

Airsystem
 Warm air is injected into the bath by 12 jets embedded in the floor of the tub.



71.... 4 .. 10

Combisystem E
 Special comfort is provided by the electronic control panel of the Combi-System E. The massageintensity of both the Air- and Jet System can be regulated separately by an integrated control panel. An electronic system protecting the Air- and Jet-System against overheating is included as standard equipment. The Combi-System E can be equipped with the following additional modules upon request: Back- and foot-massage, inlineheater, hygiene management, lighting.



71.... 2 .. 10

Jetsystem
 6 side mounted jets create maximum hydrotherapeutic action with actuated intensity of the massage, freely regulated via an air control regulator which is integrated in the rim of the tub.



71.... 5 .. 10

Combisystem L
 When activated, the control unit lights up blue. The air and jet systems, included as standard, as well as the halogen spot and the back and foot massages, are easy and convenient to operate. An electronic system protecting the Air- and Jet-System against overheating is included as standard equipment. The coloured light, the temperature L and the automatic UV hygiene management modules can all be added to the Combi-System L.

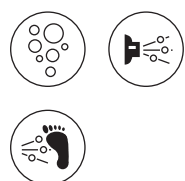

71.... 3 .. 10

Combisystem P
 A complete combination of hydrotherapy combining the Air- and Jet-System to provide excellence in system management. Additionally the system is equipped with 2 rotating jets for a footmassage. This function can be regulated with 2 pneumatic push-buttons and 1 air control regulator integrated in the rim of the tub.

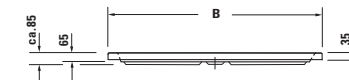
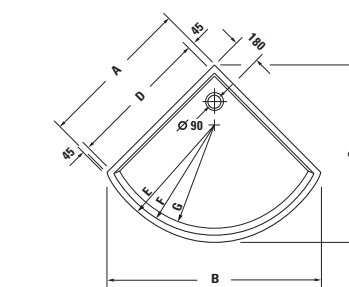
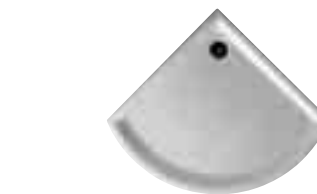

	A	B	C	D	E	F	G
#720001	900	1270	1085	830	673	628	558
#720003	1000	1410	1170	930	770	725	655

720001 .. 0 00 0000*, 900 x 900 mm
 # 720003 .. 0 00 0000*, 1000 x 1000 mm

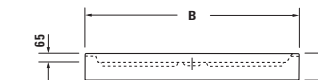
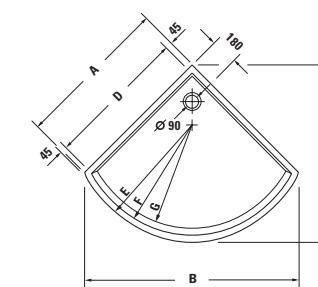

	A	B	C	D	E	F	G
#720002	900	1270	1085	830	673	628	558
#720004	1000	1410	1170	930	770	725	655

720002 .. 0 00 0000*, 900 x 900 mm
 # 720004 .. 0 00 0000*, 1000 x 1000 mm

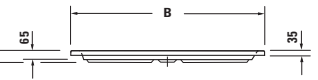
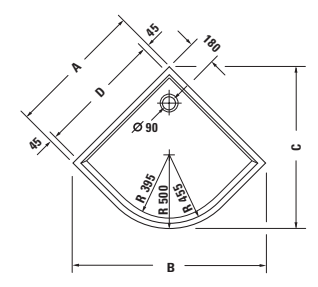

	A	B	C	D
#720030	900	1272	1065	810
#720032	1000	1414	1207	910

720030 .. 0 00 0000, 900 x 900 mm
 # 720032 .. 0 00 0000, 1000 x 1000 mm

#	A	B	C	D	E	F
#720005	900	1270	950	810	450	640
#720007	1000	1410	1055	910	500	705

#	A	B	C	D	E	F
#720006	900	1270	950	810	450	640
#720008	1000	1410	1055	910	500	705

#	A	B	C	D
#720009	800	800	710	600
#720010	900	900	810	700
#720011	1000	1000	910	800

720005 .. 0 00 0000, 900 x 900 mm
 # 720007 .. 0 00 0000, 1000 x 1000 mm

720006 .. 0 00 0000, 900 x 900 mm
 # 720008 .. 0 00 0000, 1000 x 1000 mm

720009 .. 0 00 0000, 800 x 800 mm
 # 720010 .. 0 00 0000, 900 x 900 mm
 # 720011 .. 0 00 0000, 1000 x 1000 mm

9236 L/R ↗ 394 mm # 9237 L/R ↗ 394 mm # 9333 L/R ↗ 394 mm # 9334 L/R ↗ 394 mm # 9335 L/R ↗ 394 mm

9337 L/R ↗ 397 mm # 9403 L/R ↗ 194 mm # 9404 L/R ↗ 194 mm # 9778 L/R ↗ 194 mm ☉ # 9779 ↗ 194 mm ☉

#	A	B	C	D
#720012	900	750	810	550
#720013	900	800	810	600
#720014	1000	800	910	600
#720015	1000	900	910	700

#	A	B	C	D
#720016	1200	800	1110	600
#720017	1200	900	1110	700
#720018	1200	1000	1110	800

#	A	B	C	D
#720019	1400	750	1310	550
#720034	1400	700	1310	500
#720035	1400	900	1310	700
#720036	1500	700	1410	500
#720037	1500	750	1410	550
#720038	1600	700	1510	500
#720039	1600	750	1510	550
#720040	1600	900	1510	700
#720041	1700	900	1610	700
#720042	1800	900	1710	700

720012 .. 0 00 0000, 750 x 900 mm
 # 700013 .. 0 00 0000, 800 x 900 mm
 # 720014 .. 0 00 0000, 800 x 1000 mm
 # 720015 .. 0 00 0000, 900 x 1000 mm

720016 .. 0 00 0000, 800 x 1200 mm
 # 720017 .. 0 00 0000, 900 x 1200 mm
 # 720018 .. 0 00 0000, 1000 x 1200 mm

720019 .. 0 00 0000, 750 x 1400 mm
 # 720034 .. 0 00 0000, 700 x 1400 mm
 # 720035 .. 0 00 0000, 900 x 1400 mm
 # 720036 .. 0 00 0000, 700 x 1500 mm
 # 720037 .. 0 00 0000, 750 x 1500 mm
 # 720038 .. 0 00 0000, 700 x 1600 mm
 # 720039 .. 0 00 0000, 750 x 1600 mm
 # 720040 .. 0 00 0000, 900 x 1600 mm
 # 720041 .. 0 00 0000, 900 x 1700 mm
 # 720042 .. 0 00 0000, 900 x 1800 mm

9605 ↗ 44 mm # 9606 ↗ 44 mm # 9608 ↗ 44 mm ☉ # 9609 ↗ 44 mm ☉

↔ 400 mm A	↔ 800 mm A
# 6190 L/R* 145-170mm	# 6195* 145-170mm
# 6191 L/R* 196-220mm	# 6196* 196-220mm
# 6192 L/R* 221-255mm	# 6197* 221-255mm
# 6193 L/R* 171-195mm	# 6198* 171-195mm
# 6194 L/R* 256-285mm	# 6199* 256-285mm

6130
 ↔ 800 mm, ↗ 479 mm

↔ 800 mm, ↗ 590 mm # 6166 Bacino # 032542, 420 mm # 6167 Bacino # 032542, 420 mm
 # 6166 Starck 1 # 040853, 530 mm # 6168 Vero # 045460, 600 mm
 # 6167 Starck 1 # 044753, 530 mm # 6168 Vero # 045360, 600 mm
 # 6167 Starck 1 # 044648, 480 mm # 6169 Vero # 045560, 600 mm

Drawer partitioning for drawers
 ↔ 400 mm, ↗ 394 mm
 # 8089 ↔ 304 mm, ↗ 274 mm
 2 small compartments 78,5 x 105 x 95 mm
 2 large compartments 157 x 105 x 95 mm
 5 open compartments

* = Recommended ceramics for universal vanity units, please refer to price list

1 # 030348..00 ○ ● ○
2 # 6164 jetty cube
0050270000 Siphon

1 # 030648..00 ● ● ● ●
2 # 6164 jetty cube
0050270000 Siphon

1 # 030348..00 ○ ● ○
2 # 0030641000

2 # 030648..00 ● ● ● ●
3 # 0030641000

Mirror 325 mm
9712
 Mirror with light
9713

Mirror 450 mm
9766
 Mirror with light
9767

030410..00 ○ ● ○
6084

030410..00 ○ ● ○
6085

030410..00 ○ ● ○
030480..00 ○ ● ○
6086

030410..00 ○ ● ○
030480..00 ○ ● ○
6087

030480..00 ○ ● ○
030470..00 ○ ● ○
6088

030480..00 ○ ● ○
030470..00 ○ ● ○
6089

X Exact measurement by positioning of pedestal underneath basin
± measurement depending on vanity unit
 ○ 1 pre-punched tap hole
 ● 1 tap hole punched
 ○ ● 2 pre-punched tap holes
 ○ ● ○ 1 tap hole punched, 2 additional ones possible (please indicate when ordering)
 ● ● ● 1 tap hole punched, 2 pre-punched
 ● ● ● ○ 2 tap holes punched
 ● ● ● ● 3 tap holes punched
 ⊗ without tap hole (smooth)

⊥ installation from below
⊥ installation from above
 ● toilets and cistern with 6 l flushing water
 ○ Vertical outlet
 ○ Horizontal outlet
 ← supply left
 → supply right
 ↔ back supply
 ↙ supply bottom left
 ↘ Depth
 ↔ Width
 L/R Left/Right
 ☉ with lighting

White - 00
 Pergamon - 47

Duravit AG
Werderstr. 36
78132 Hornberg
Germany
Phone +49 7833 70 0
Fax +49 7833 70 289
info@duravit.com
www.duravit.com

Austria

Duravit Vertrieb Österreich:
Laufen Austria AG
Mariazeller Straße 100
3150 Wilhelmsburg
Phone +43 2746 6060 0
Fax +43 2746 6060 390
office@at.laufen.com
www.duravit.com

Belgium/Luxemburg

Duravit BeLux S.p.r.l./B.v.b.a.
83, Rue des Combattants
1310 La Hulpe
Phone +32 2 6560510
Fax +32 2 6560515
info@be.duravit.com
www.duravit.be

China

Chongqing Duravit
Sanitaryware Co. Ltd.
Suite B-D 10F, Jiushi Tower,
No. 28 Zhongshan Nan Road
Shanghai, p.c. 200010
Phone +86 21 33020227
Fax +86 21 63304807
info@cn.duravit.com
www.duravit.com

CIS

Duravit CIS
Repr. Office Moscow
Petrovka 27, Office 245
Moscow 10 70 31
Phone +7 095 937 5553
Fax +7 095 937 5557
info@ru.duravit.com
www.duravit.com

Czech Republic/Slowakia

Duravit CZ
Jungmannova 2
669 02 Znojmo
Phone +420 515 220 155
Fax +420 515 220 154
duravit.cz@tiscali.cz
www.duravit.com

Denmark

Duravit Danmark
Jegstrupvej 6
8361 Hasselager
Phone +45 8626 6000
Fax +45 8626 6001
info@dk.duravit.com
www.duravit.com

Egypt

Duravit Egypt
20, Salah Salem Street
Heliopolis - Cairo
Phone +2 02 4175631
Fax +2 02 4153702
duravit.egypt@eg.duravit.com
www.duravit.com

France

Duravit S.A.
Rue de Marienthal 30010
67241 Bischwiller Cedex
N° Indigo +33 820 820 414
Fax +33 388 906 101
info@fr.duravit.com
www.duravit.fr

Hungary

Duravit Hungary
Magyarországi Képviselet
Cím: 2083 Solymár, Panoráma u. 30
Levelezési cím: 2083 Solymár, Pf. 77
Phone +36 26 564465
Fax +36 26 564466
csaba.varkonyi@hu.duravit.com
www.duravit.com

India

Duravit India
117, Devpath, B/h Lal Bungalow
Off. C. G. Road, Ellisbridge
Ahmedabad - 380006
Gujarat State - India
Phone +91 79 2640 3093
Fax +91 79 2646 9876
info@in.duravit.com
www.duravit.com

Italy

Duravit Italia S.R.L.
Via Faentina 213
48010 Fornace Zarattini (RA)
Phone +39 0 544 509711
Fax +39 0 544 501694
info@it.duravit.com
www.duravit.it

Middle East

DURAVIT Middle East S.A.L.
(OFF SHORE)
Sodeco Square Building
Bloc B, 14th floor
Sodeco-Beirut
Lebanon
Phone +961 1 397330
Fax +961 1 397329
info@lb.duravit.com
www.duravit.com

Netherlands

Duravit Nedertand B.V.
Postbus 1160
5200 BE 's-Hertogenbosch
Phone +31 73 6131970
Fax +31 73 6100983
info@nl.duravit.com
www.duravit.com

Poland

Duravit Poland
ul. Krasynskiego 74/11
71-447 Szczecin
Phone +48 604 544 588
Fax +48 914 316 323
info@pl.duravit.com
www.duravit.com

Portugal

Duravit Portugal
Rua Antoine de Saint-Exupéry
Alapraia
2765-043 Estoril
Phone +351 21 466 7110
Fax +351 21 466 7119
duravit@jrb.pt
www.duravit.com

Singapore and South East Asia

Duravit Singapore
#15-20, Block 16
River Valley Close
Singapore 238433
Phone +65 6733 1748
Fax +65 6735 7548
info@sg.duravit.com
www.duravit.com

Spain

Duravit España S.L.
Zona Industrial Z
Carrer de la logística, 18
08150 Parets del Valles
(Barcelona)
Phone +34 902 387 700
Fax +34 902 387 711
www.duravit.es
info@es.duravit.com

Switzerland

Duravit Vertrieb Schweiz:
KERAMIK LAUFEN AG
Wahlenstrasse 46
4242 Laufen
Phone +41 61 7657575
Fax +41 61 7615711
info@center@laufen.ch
www.duravit.com

Turkey

Duravit Yapı Ürünleri San. ve Tic. A.Ş.
Organize Deri Sanayi Bölgesi
10, Yol I-4 Parsel
34956 Tuzla/Istanbul
Phone +90 216 4585151
Fax +90 216 4585195
info@tr.duravit.com
www.duravit.com

United Kingdom

Duravit UK, Limited
Unit 7 Stratus Park
Brudenell Drive, Brinklow
Milton Keynes, MK10 0DE
Phone +44 870 7307787
Fax +44 870 7307786
info@uk.duravit.com
www.duravit.co.uk

USA

Duravit USA, Inc.
1750 Breckinridge Parkway
Suite 500
Duluth, GA 30096
Phone +1 770 9313575
Fax +1 770 9318454
info@usa.duravit.com
www.duravit.us

